

Tollco Whitegoods underlay

Drip tray Fridge/Freezer Pro

- **Detect water leakage in time.**
- **Prevents water damage under refrigerators and freezers.**

**Prevents
water damage.**
Collects and diverts
condensation.

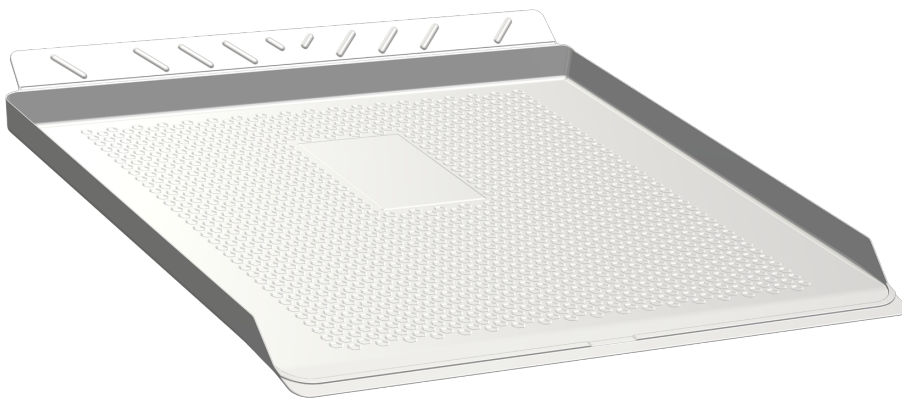

Pro-series condensation protection is placed under refrigerators and freezers to prevent condensation and water damage. They are designed to quickly collect condensation and leakage from hidden areas and divert it out from the centre in front of the refrigerator and freezer. This way, you avoid unnecessary water damage.

The mat is semi-transparent and made of impact-resistant polypropylene plastic and is available in one standard size. The installation instructions are easy to follow and of course approved by Säker Vatten.

Type approved 0505/01 and meets the requirements of the provisions in the Swedish National Board of Housing, Building and Planning's building regulations: BBR: Hidden areas in rooms or building components 6:5334. Sold in well-stocked hardware stores, appliance chains and at plumbing wholesalers. Made in Sweden.

TOLLCO AB Rubanksgatan 4, 741 71 Knivsta.
Tel +46 18 34 90 10. info@tollco.se **tollco.se**

TOLLCO
Your protection against water damage

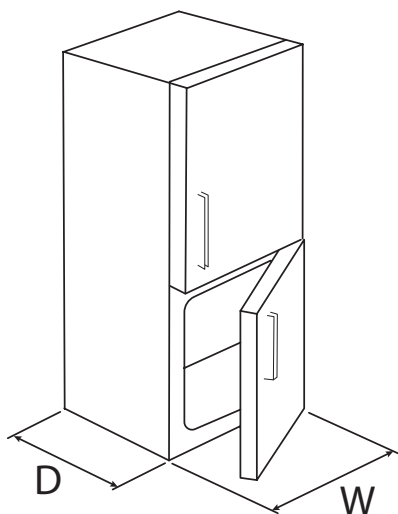

D dimensions from front edge
(without door)

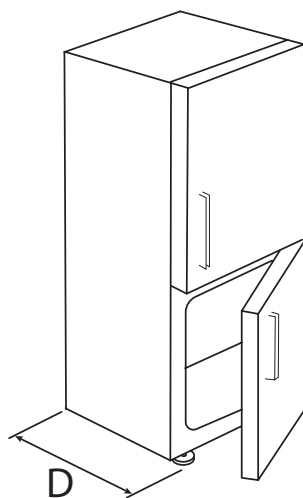

D dimensions from foot of front edge
(without door)

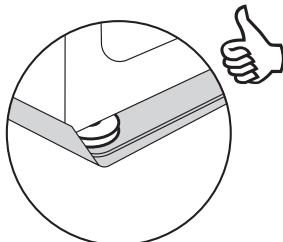
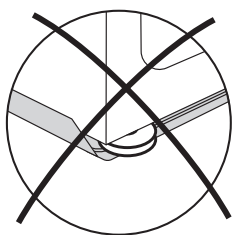
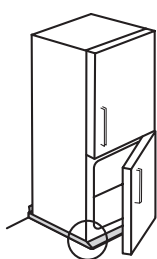

Meets the requirements

Tollco mats for the Standard and Pro series meet the requirements in Chapter 8, Section 4-3 of the Swedish Planning and Building Act in the respects and under the conditions specified in type approval 0505/01 and are therefore approved in accordance with the provisions in the following section of the Swedish National Board of Housing, Building and Planning's construction rules: BBR: Hidden areas in rooms or building components 6:5334.

Product	RSK no.	Item no.	Dimensions, WxDxH (mm)	W	D
Tollco Drip tray Fridge/Freezer Pro 60x56 cm	8039002	516058	596x555x40 mm	0-60 cm	0-55 cm

SCAN CODE FOR MORE
INFO ABOUT THE PRODUCT.



Accepterad
monteringsanvisning
2021:1



Produkten bedömd i
SundaHus Miljödata

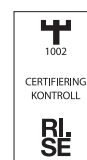

Tgnr 0505/01

Made in Sweden. Recommended by insurance companies.

TOLLCO AB Rubanksgatan 4, 741 71 Knivsta.
Tel +46 18 34 90 10. info@tollco.se **tollco.se**

TOLLCO
Your protection against water damage

20230116