



**Silentia+**  
***SALICE***



The state of the soft-close art.

Silentia+ allows a perfect and constant closing of the door in any condition, use and application.

The innovative soft-close technology guarantees excellent performances to the complete range of hinges. Silentia+ includes numerous technological elements in the required spaces and maintains the aesthetics of the hinges of the first generation.



## Second generation

Integrated soft-close technology with two silicone oil dampers.

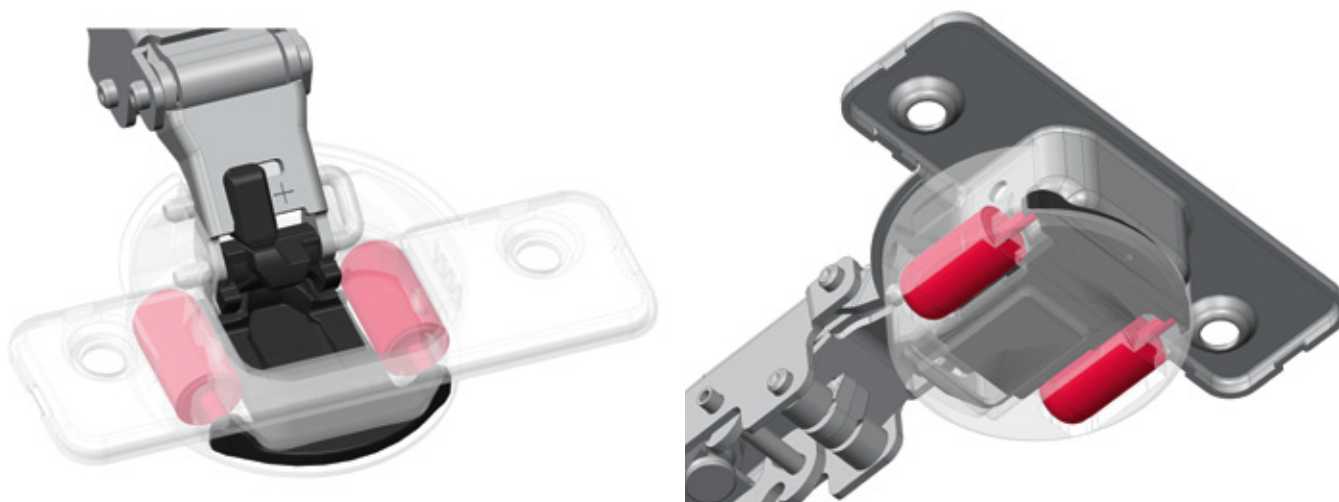

The two integrated dampers guarantee an exceptional regularity of the decelerating strength providing a perfect closing to any kind of door and condition.



## Ever-optimal soft-close action

Silentia+ is also equipped with the innovative switch to delay the decelerating action. The activation of this switch allows, even to special doors, to obtain the ideal decelerating strength.

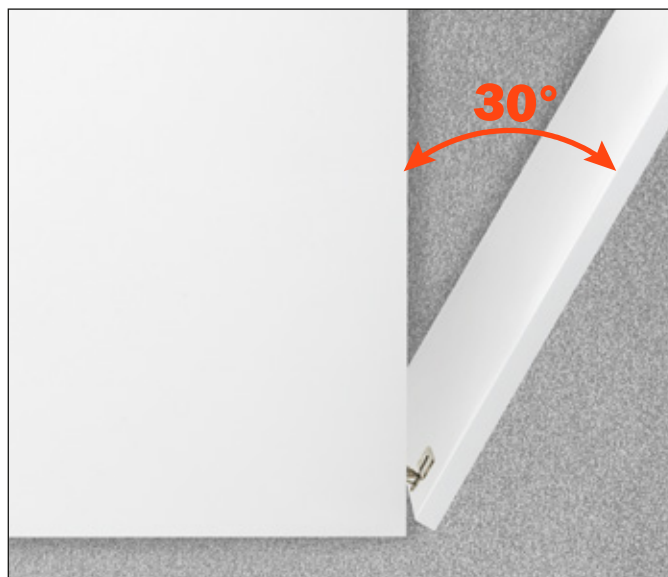
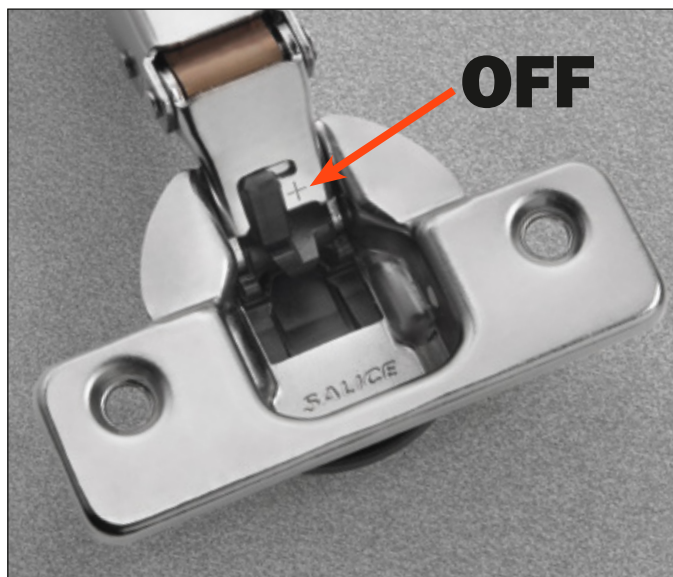







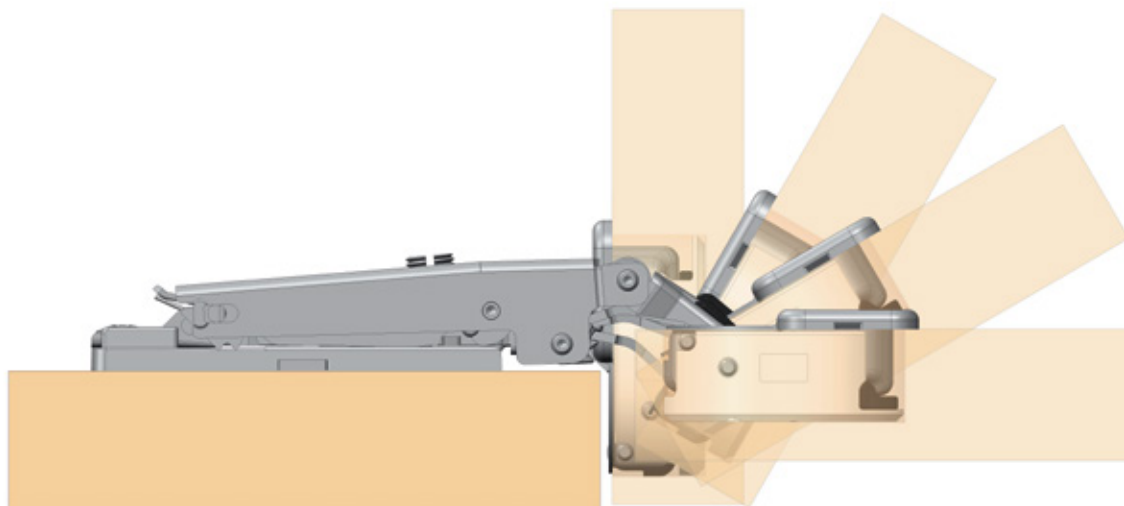

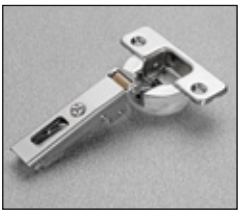

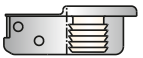
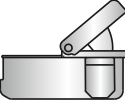



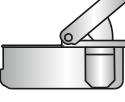

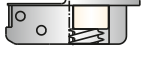

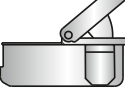
## The tradition

Range, kinematics and adjustments remain unchanged and ensure once again the most comprehensive offer available on the market.

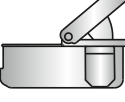
Silentia+ does not require any change of mounting plates.

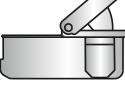

	DESCRIPTION	FIXINGS			
	<p>Series 100. Hinges for doors of small weight and reduced thickness. 12 mm cup depth.</p>				
	<p>Series 200, for thicker doors. Hinges for min. 18 mm thick doors. 15.5 mm cup depth.</p>				
	<p>Series 700. Hinges for min. 16 mm thick doors. 13.5 mm cup depth.</p>				
	<p>Series 200, 155°, 0 protrusion.</p>				
	<p>Series 300. Hinges for display cases and cabinets with wooden or metal pilasters.</p>				

## More technology in the same spaces

Silentia+ has identical dimensions and shape as the previous generation, in spite of the new double-piston technology and the deceleration switch.

These features allow the complete interchangeability both inside the cabinet and during the drilling process and the insertion on the door.

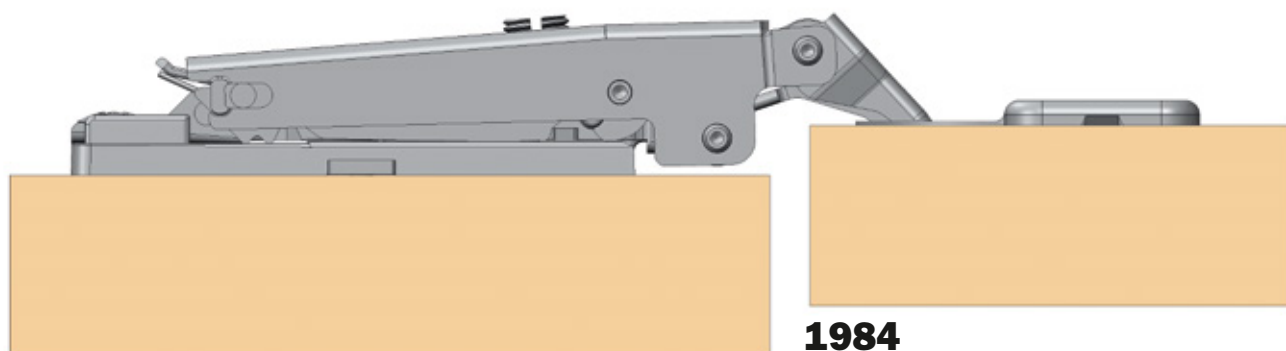

**1984**

**Series 200**

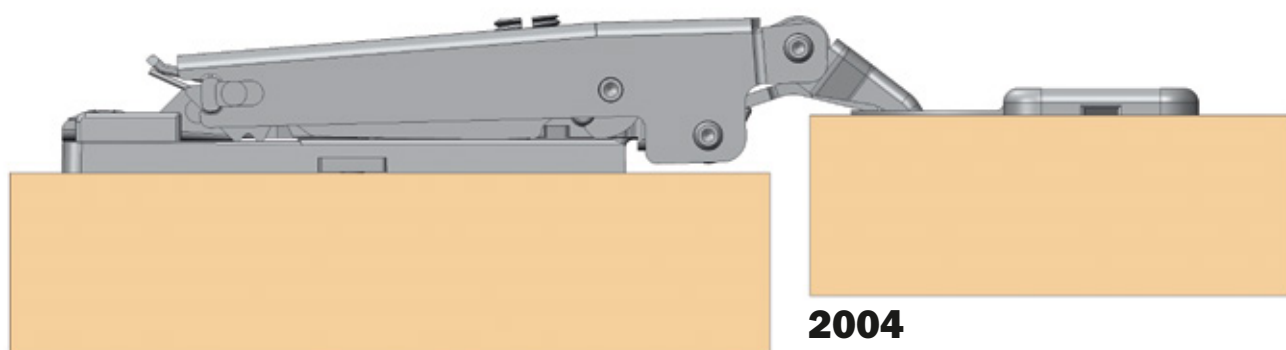

**2004**

**Silentia**

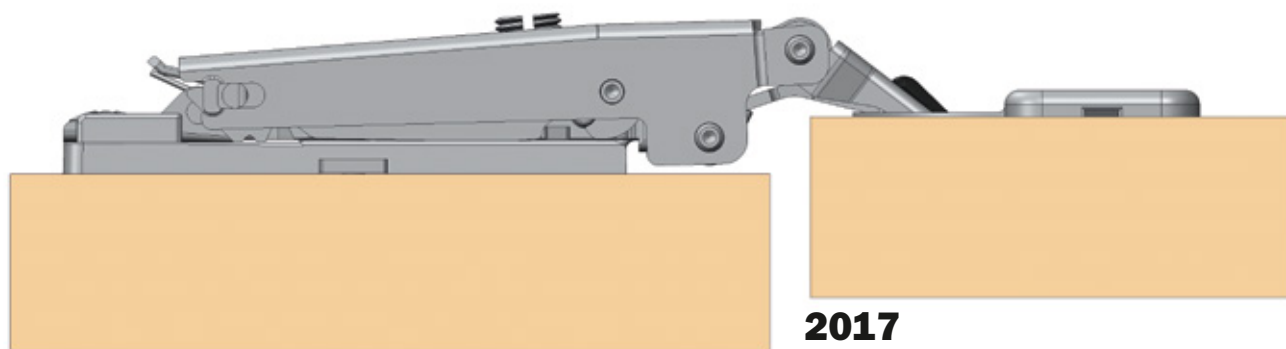

**2017**

**Silentia+**

## **ARTURO SALICE S.p.A.**

VIA PROVINCIALE NOVEDRATESE, 10  
22060 NOVEDRATE (COMO) ITALIA  
TEL. 031 790424  
FAX 031 791508  
info.salice@salice.com  
www.salice.com

### **DEUTSCHE SALICE GMBH**

RUDOLF DIESEL STR. 10  
POSTFACH 1154  
74382 NECKARWESTHEIM  
TEL. 07133 9807-0  
FAX. 07133 9807-16  
info.salice@deutschesalice.de  
www.deutschesalice.de

### **DEUTSCHE SALICE GMBH**

VERKAUFSBÜRO NORD  
RINGSTRASSE 36/A30 CENTER  
32584 LÖHNE  
TEL. 05731 15608-0  
FAX. 05731 15608-10  
vknord@deutschesalice.de  
www.deutschesalice.de

### **SALICE FRANCE S.A.R.L.**

ROUTE DE GOA ZAC LES 3 MOULINS  
06600 ANTIBES  
TEL. 0493 330069  
FAX. 0493 330141  
info.salice@salicefrance.com  
www.salicefrance.com

### **SALICE ESPAÑA, S.L.U.**

CALLE COPÉRNICO, 11  
POLÍGONO INDUSTRIAL  
COLL DE LA MANYA  
08403 GRANOLLERS (BARCELONA)  
TEL. 938 45 88 61  
FAX 938 49 11 97  
info.salice@saliceespana.es  
www.saliceespana.es

### **SALICE UK LTD.**

KINGFISHER WAY  
HINCHINGBROOKE BUSINESS PARK  
HUNTINGDON CAMBS PE 29 6FN  
TEL. 01480 413831  
FAX. 01480 451489  
info.salice@saliceuk.co.uk  
www.saliceuk.co.uk

### **SALICE AMERICA INC.**

2123 CROWN CENTRE DRIVE  
CHARLOTTE NC. 28227  
TEL. 704 8417810  
FAX. 704 8417808  
info.salice@saliceamerica.com  
www.saliceamerica.com

### **SALICE CANADA INC.**

4025 SLADEVIEW CRESCENT  
UNIT # 7-9  
MISSISSAUGA, ONTARIO L5L 5Y1  
TEL. 905 8208787  
FAX. 905 8207226  
info.salice@salicecanada.com  
www.salicecanada.com

### **SALICE CHINA**

#### **(SHANGHAI) CO. LTD.**

1st FLOOR, B1 BLDG 928 MINGZHU ROAD  
XUJING, QINGPU DISTRICT  
SHANGHAI 201702 - CHINA  
Tel. 021 3988 9880  
Fax 021 3988 9882  
info.salice@salicechina.com  
www.salicechina.com



#### **Digital contents:**

- **Technical pamphlet in Pdf format**
- **Video**

**We reserve the right to change technical specifications without notice.**