

DRIVER 50W

LED 24V - IN 220÷240V

IT Driver per LED con cavo e spina - Tipo indipendente per uso interno, tensione di uscita costante 24V; protetto contro il corto circuito e il sovraccarico.

EN LED driver with cable and plug - Independent type for internal use, constant exit voltage 24V, protected against short circuit and overload.

DE LED-Konverter mit Kabel und Stecker - Unabhängige Konverter mit staendiger Ausgangsspannung 24V, kurzschlussfest und ueberbelastungsgeschuetzt.

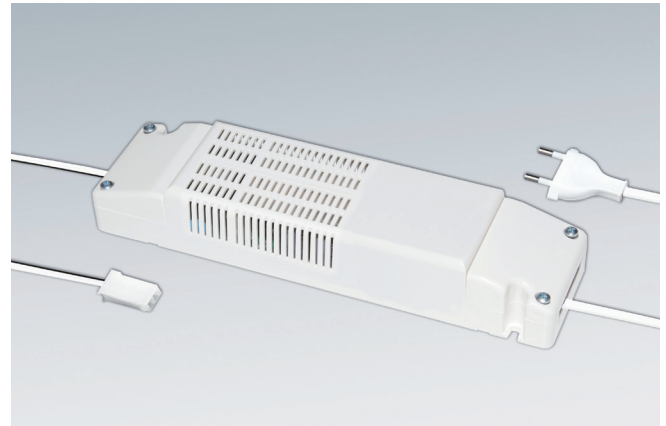

CE ENEC EMC SELV

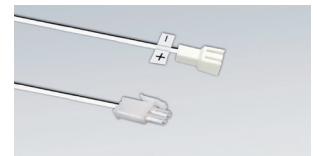
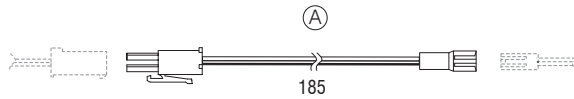
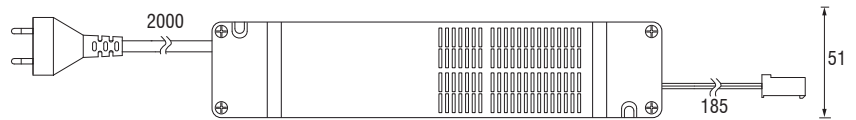
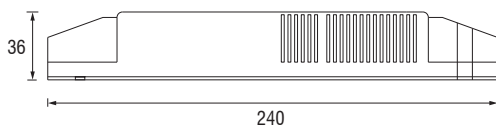

(A) Cavo per connessione singola
Single connection cable
Einzelverbindungskabel

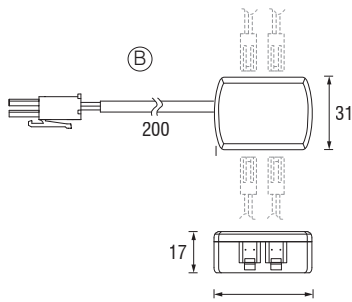

(B) Distributore a 4 uscite
4-way distribution box
4-fach Verteiler

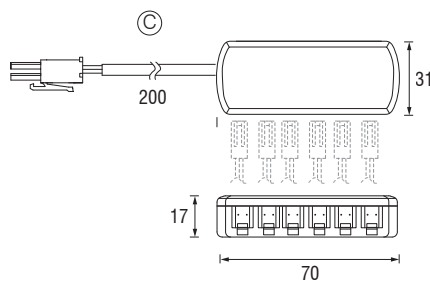

(C) Distributore a 6 uscite
6-way distribution box
6-fach Verteiler

Alimentatore - Driver - LED-Konverter				
V IN	Hz	V OUT	W	Codice - Part no. - Artikel-Nr.
220V÷240V	50...60Hz	24V	50W	3T492801

Imballo - Packaging - Verpackung		
Pcs	Kg	mm
1	0,352	40 x 70 x 210

Accessori - Accessories - Zubehör		Codice - Part no. - Artikel-Nr.
(A)	Prolunga / Extension / Verlängerungskabel	6LC10008
(B)	4 uscite / 4 Way / 4-fach	1T3001
(C)	6 uscite / 6 way / 6-fach	1T3002

Pcs	Kg
1	0,005
1	0,021
1	0,028

Dimensioni in millimetri (mm)
Dimensions in Millimeters (mm) - Dimensionen in Millimetern (mm)

Compatibile con prodotti LED 24V
Compatible with 24V LED products - Kompatibel mit 24V LED Produkten

