

COBRA

Glass shelf support.

In accordance with the regulation UNI EN 14749/05.

Zinc alloy
Engineering plastic



UNI EN 14749/05.

INSTALLATION

Assembling with smooth pin

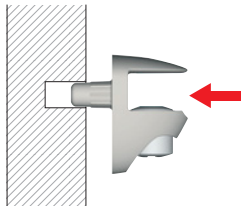

Assembling with alternative fixing options
to achieve horizontal connection

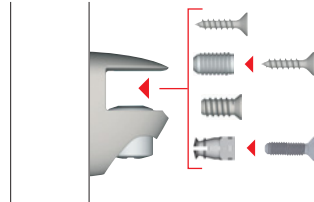

Metric insert in engineering plastic
cross PZ2 screwdriver

SHELF INSTALLATION

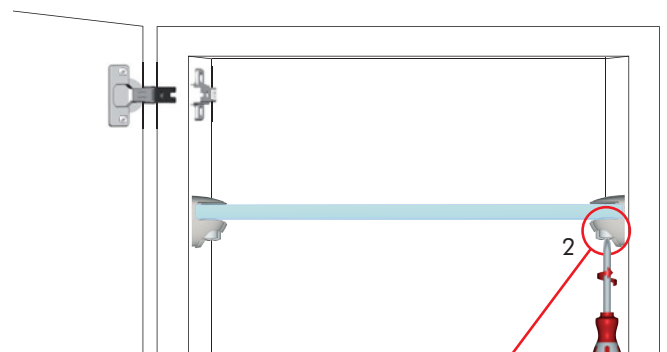
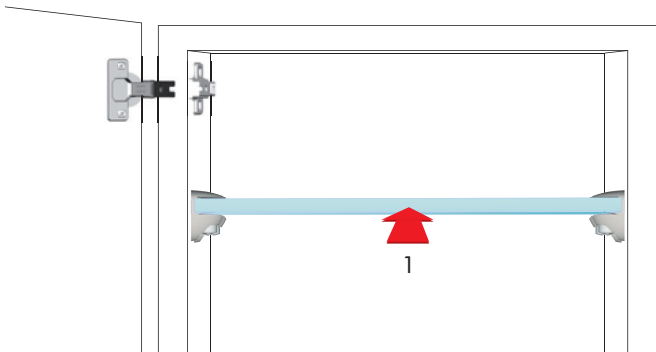

SHELF REMOVAL FOR NEW REPOSITIONING

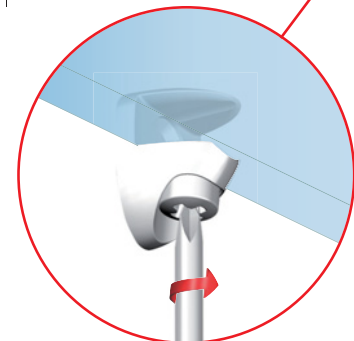
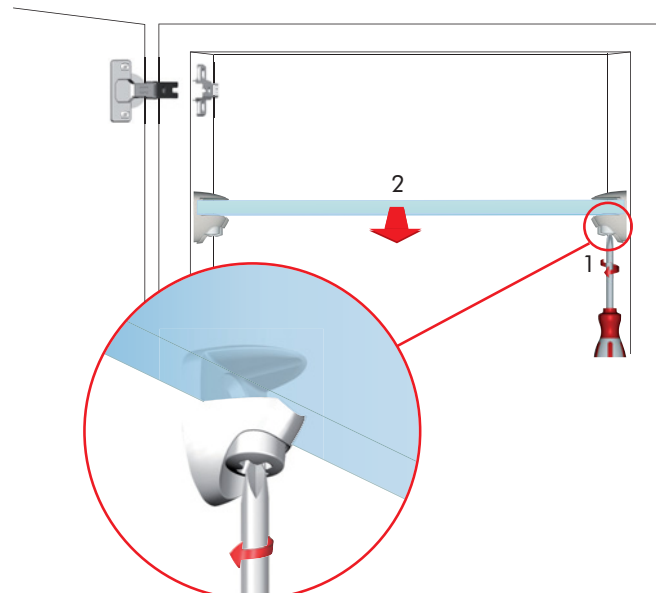

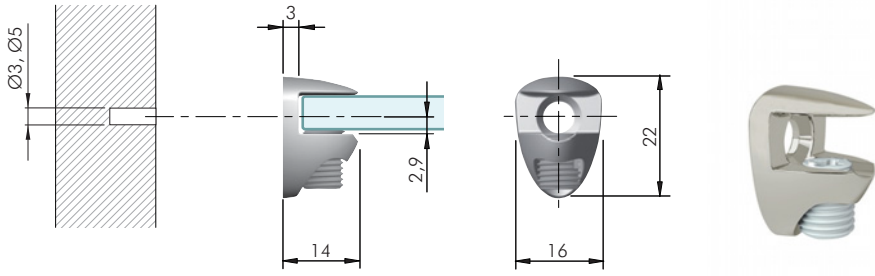

= Ø 3, Ø 5 mm +

= 5 - 6 mm = PZ2

ZA EPn = 2500 pcs.

123

16014010YA

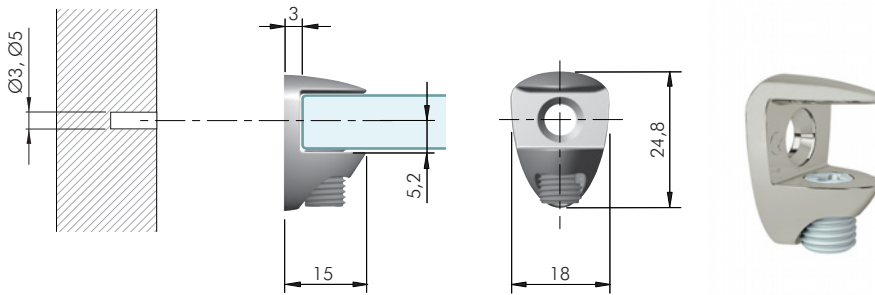

= Ø 3, Ø 5 mm +

= 8 - 10 mm = PZ2

ZA EPn = 2500 pcs.

123

16014020YA

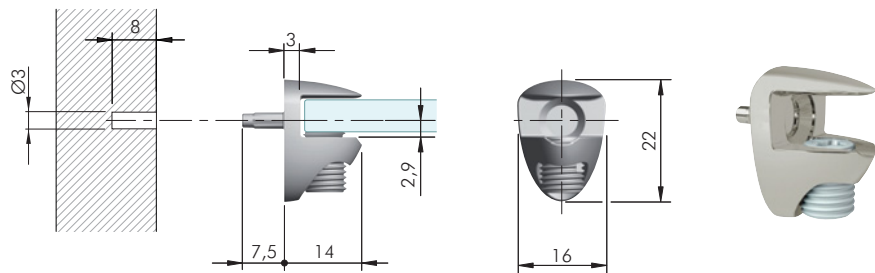

= Ø 3 mm +

= 5 - 6 mm = PZ2

ZA EPn ST = 2500 pcs.

123

16014090YA

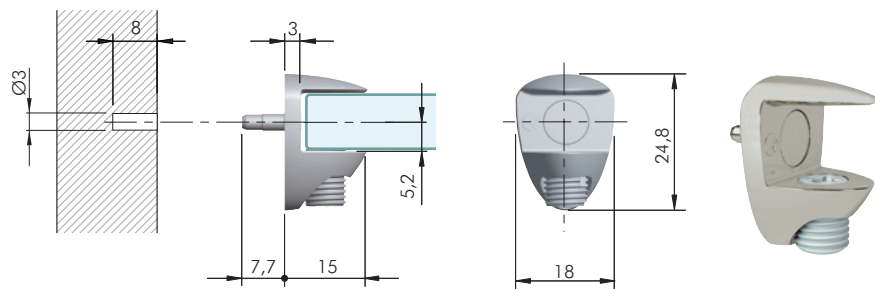

= Ø 3 mm +

= 8 - 10 mm = PZ2

ZA EPn ST = 2500 pcs.

123

16014060YA

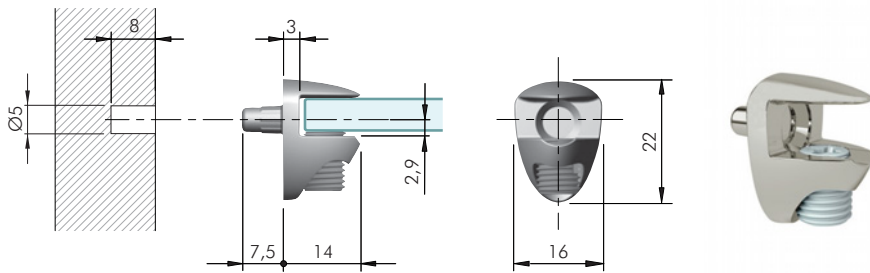

= Ø 5 mm +
 = 5 - 6 mm = PZ2
 ZA EPh = 2500 pcs.

16014030YA

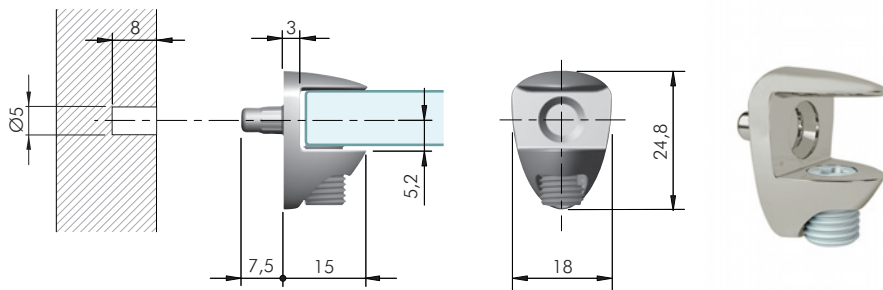

= Ø 5 mm +
 = 8 - 10 mm = PZ2
 ZA EPh = 2500 pcs.

16014040YA

COBRA FIXING ACCESSORIES

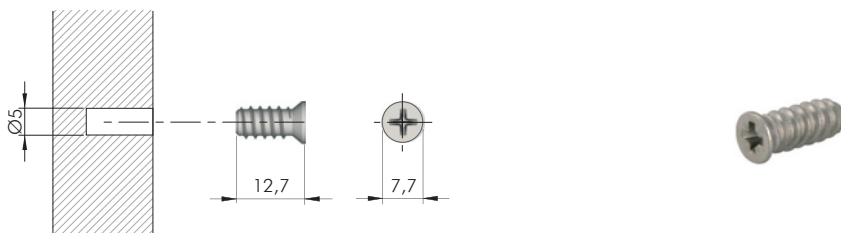

= Ø 5 mm +
 = PZ2
 ST = 5000 pcs.



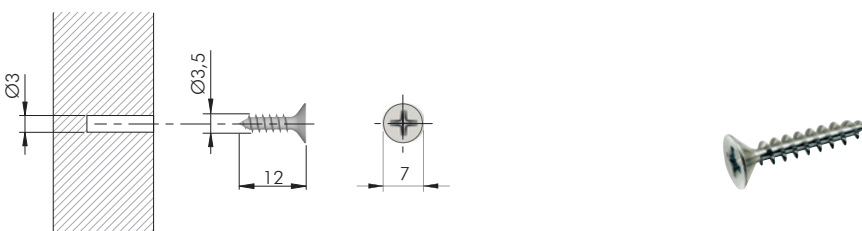

60501050YA

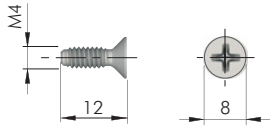

= Ø 3 mm
 = PZ2
 ST = 10.000 pcs.

60101380ZN





 = M4
  = PZ2
 ST
  = 2000 pcs.

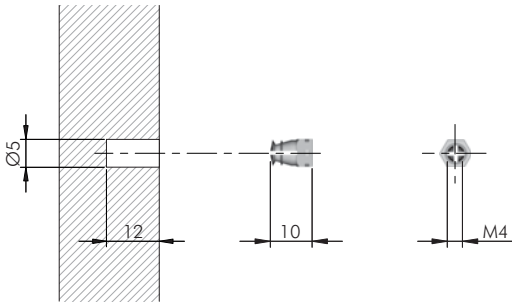

 123
 60305040Z**N**



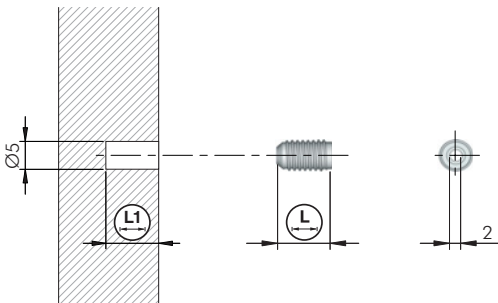

 = Ø 5 mm
  = M4
 BR
  = 20.000 pcs.

 123
 20502021**HL**



 = Ø 5 mm
 EPn
  = 5000 pcs.

 123
 20302020**AA**
 9,5
  11,5