

KUBIC

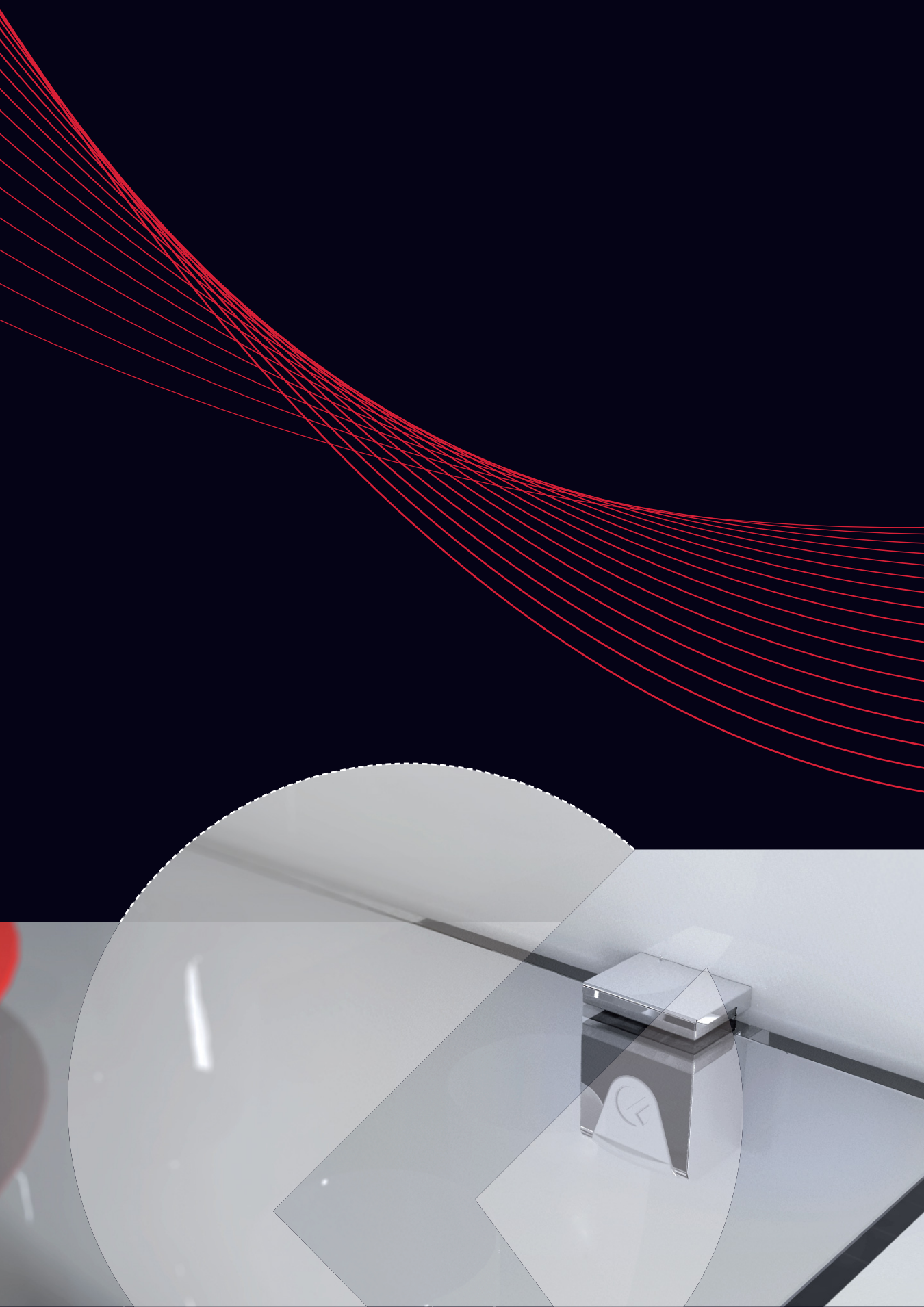

GLASS SHELF
SUPPORTS



KUBIC

KUBIC is the new locking glass shelf support, freshly designed to match the contemporary aesthetic trends of the market. Conceived to guarantee furniture transportation with glass shelves already assembled. locking and unlocking of the glass shelf can be carried out manually without any tool. Glass is blocked on both upper and lower side by soft rubber elements, in accordance with the actual function and safety norms. It is suitable for glass shelves 4-8 mm thick.

It is available in 4 different versions:

- Ø 3mm pin
- Ø 5mm pin
- screw hole for 3.5x16mm countersunk wood screw
- screw hole for M4x16mm countersunk screw

Zinc Alloy, Engineering Plastic.

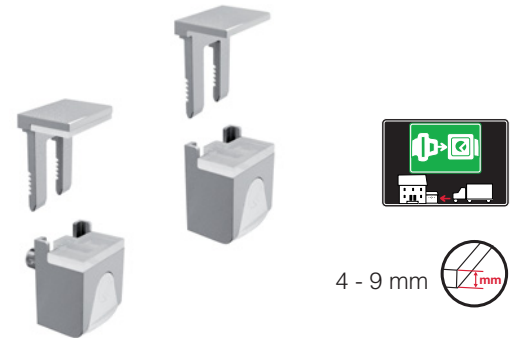

4 - 9 mm 

PAT. PENDING - UNI EN 14749/05 

INSTALLATION

Assembling with smooth pin

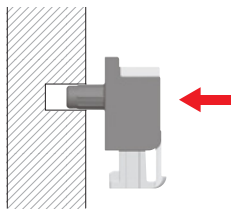

Assembling with alternative fixing options to achieve horizontal connection

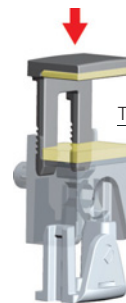
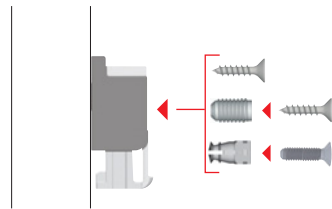

The coloured parts are in clear soft rubber

SHELF INSTALLATION

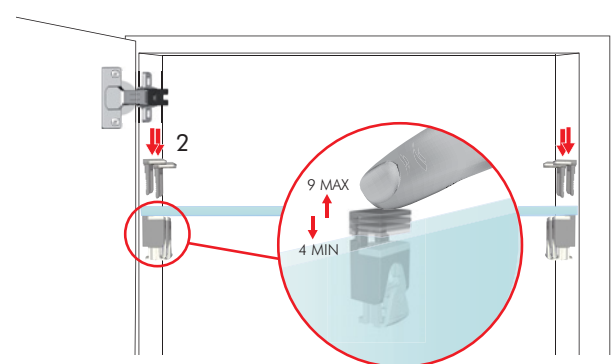
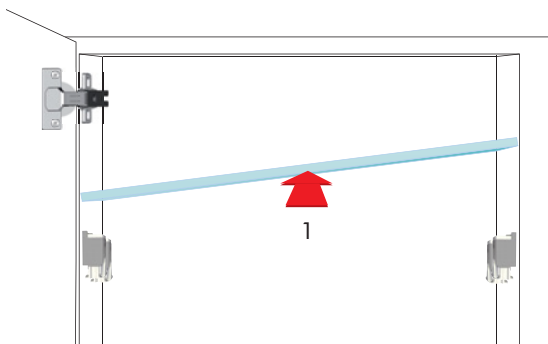

SHELF REMOVAL FOR NEW REPOSITIONING

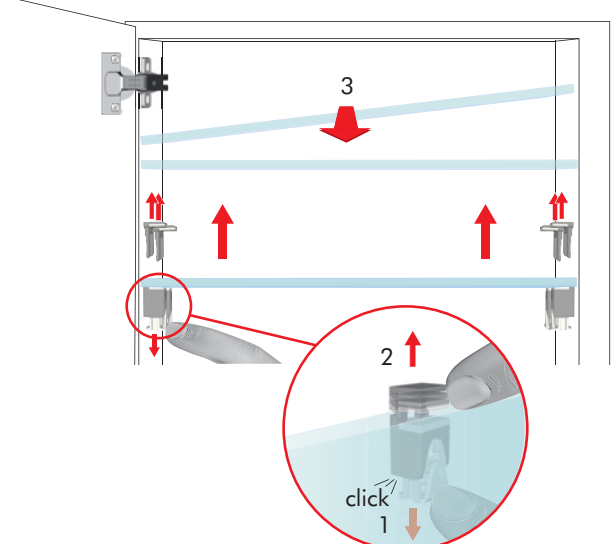
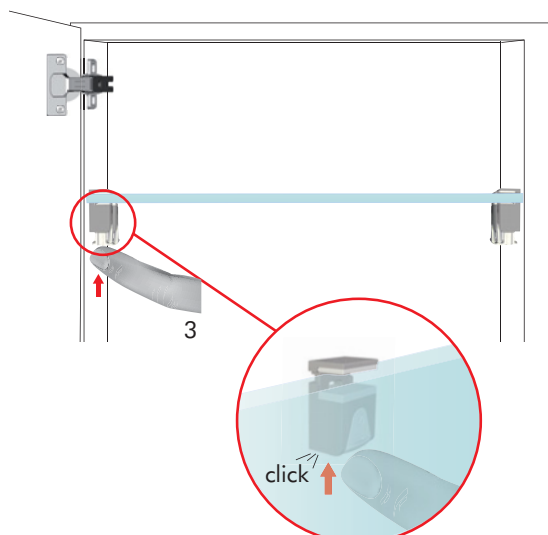

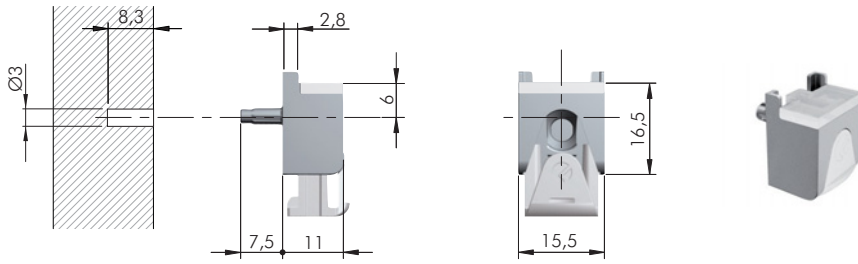

= Ø 3 mm +

ZA SRn EP

= 2000 pcs.



16019010YA

EP

EPg

16019011YA

EPw

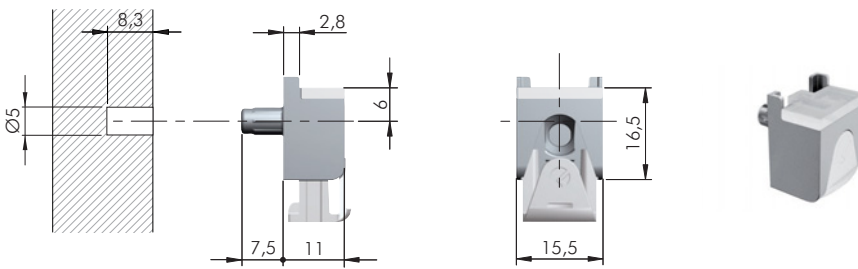

= Ø 5 mm +

ZA SRn EP

= 2000 pcs.



16019020YA

EP

EPg

16019021YA

EPw

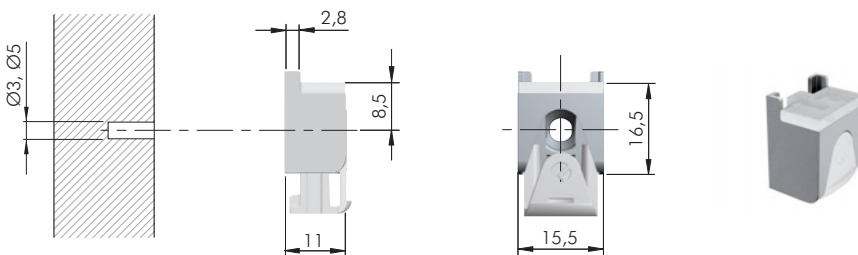

= Ø 3, Ø 5 mm +

ZA SRn EP

= 2000 pcs.



16019030YA

EP

EPg

16019031YA

EPw

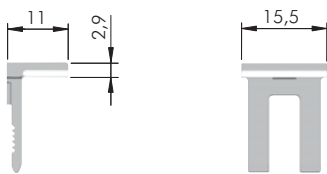

= 4 - 8 mm +

ZA SRn

= 2000 pcs.



16019140YA

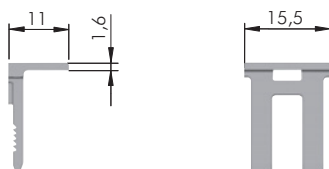

= 5 - 9 mm +

ZA







= 2000 pcs.

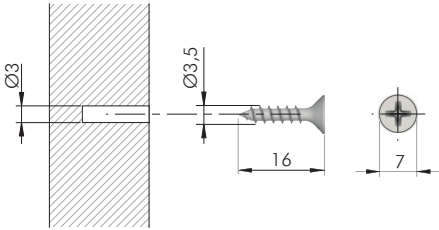



16019130YA





KUBIC FIXING ACCESSORIES

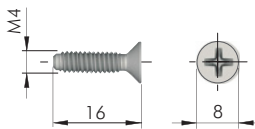

 = Ø 3 mm
   = PZ2
 ST  = 10.000 pcs.

 123 
 60101390ZN



  = M4  = PZ2
 ST  = 2000 pcs.

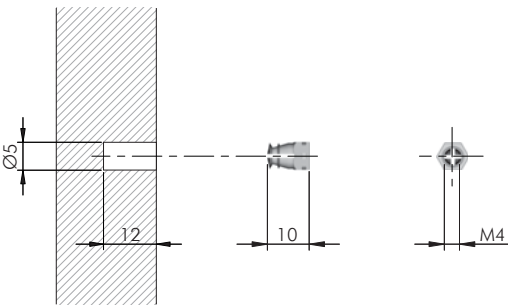

 123 
 60305060ZN





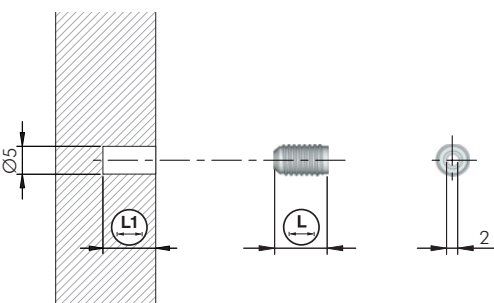

 = Ø 5 mm  = M4
 BR  = 20.000 pcs.

 123 
 20502021HL



 = Ø 5 mm
 EPn  = 5000 pcs.

 123 
 20302020AA  9,5  11,5